



TECHNICAL DATA

RATED FLOW [M3/H]	4m3/hr
MAX FLOW	6m3/hr
MAX HEAD	92.4M
OPTIMUM OPERATING RANGE	2.41m3/hr @ 84.9m 38.8% eff 5m3/hr @ 75.4m 55.8% eff
WORKING AIR TEMP	0°C - 40°C
LIQUID TEMPERATURE	-15°C - 120°C
HIGHEST EFFICIENCY	57.11%
MAXIMUM PUMP PRESSURE	33 bar
NET WEIGHT (KG)	36.1kg

RATED VOLTAGE/CURRENT	Three phase 415V +10% - 6%
RATED CURRENT	4.41 amps
POWER (KW)	2.2kW 2 pole
MOTOR IP RATING	IP55
MOTOR INSULATION	Class F
MOTOR EFFICIENCY STD	I.E.3
MOTOR EFFICIENCY	84.2%
COS Ø	0.84
MECHANICAL SEAL	AS-L-12
OUTLET DIN FLANGE	DN32

INCLUDES

- VMS Pump
- NXT Drive (Variable Frequency Drive)
- Counter Flange (In DN25 to DN65)
- Fiber Gaskets to suit counter flanges
- Watermarked Spring Check Valve
- Manifold (304 Stainless Steel)
- Pressure Transducer
- 30 Bar Liquid Filled Pressure Gauge
- Galvanised Single/Double/Triple Base
- Ball Valve (304 Stainless Steel)
- Pressure Tank Included in Scope of Supply
- Braided Hose 20 Bar 1.5m 1" BSPF with 10/6 model only

DIMENSIONS

BASE WIDTH & LENGTH 275

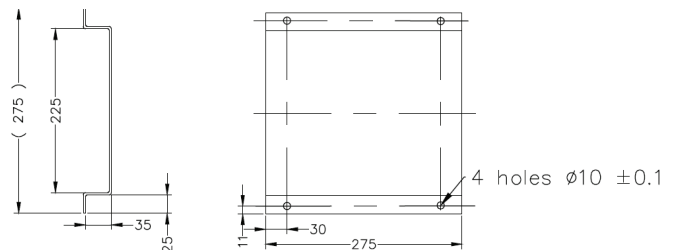

PRODUCT DATA SHEET

SUMMIT SERIES VERTICAL MULTISTAGE

DRIVE KIT

BIA-1VMS5/8T-DRIVE • 812402

CURVE

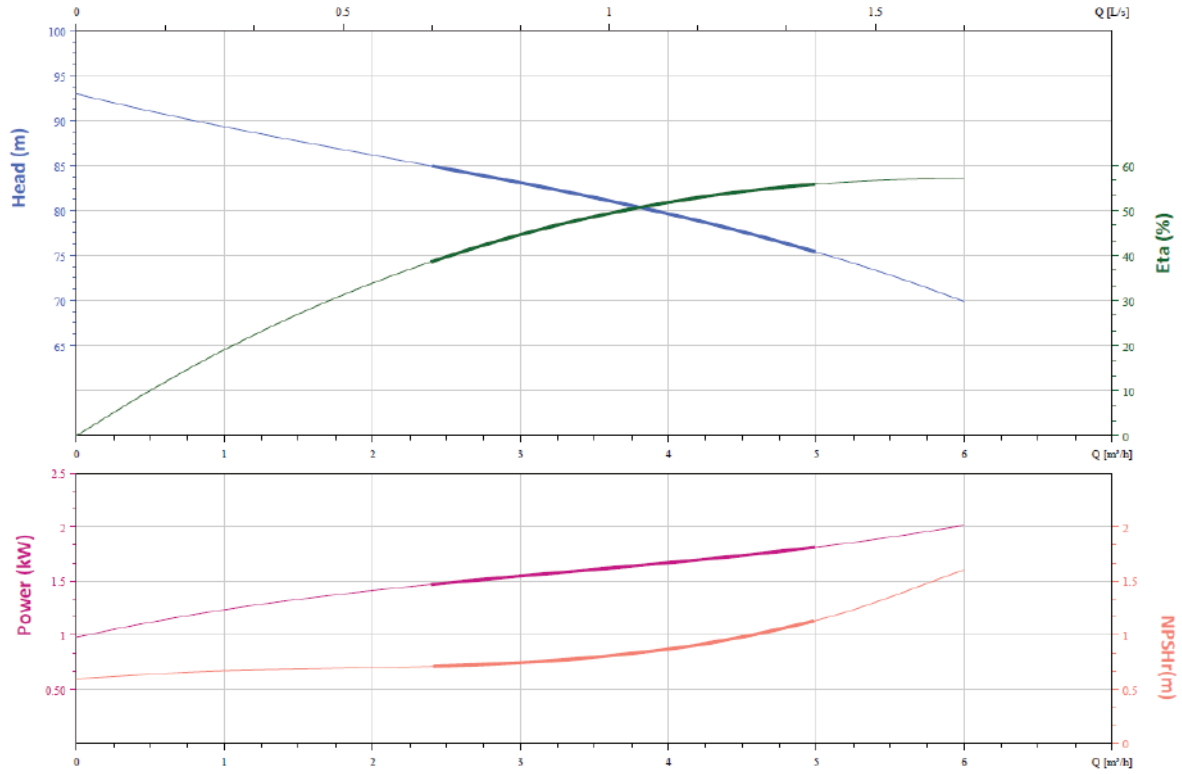

VFD CURVE

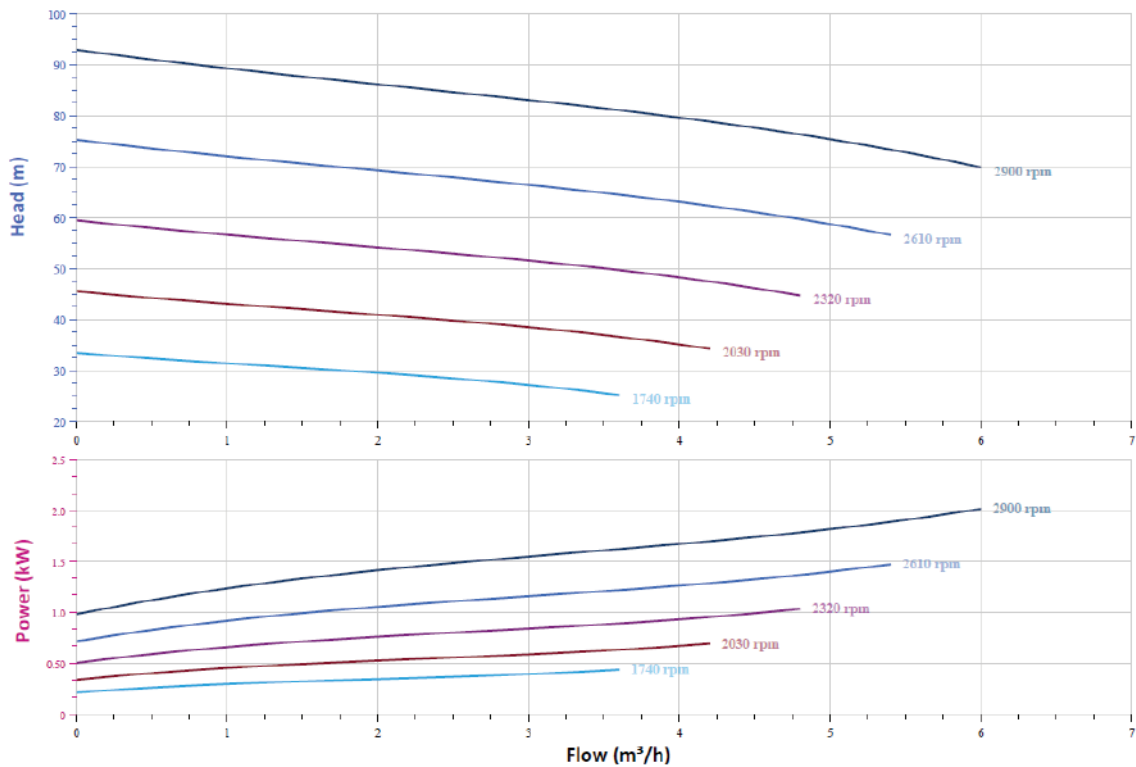

PRODUCT DATA SHEET

SUMMIT SERIES VERTICAL MULTISTAGE

DRIVE KIT

BIA-1VMS5/8T-DRIVE • 812402

DUAL PUMP CURVE

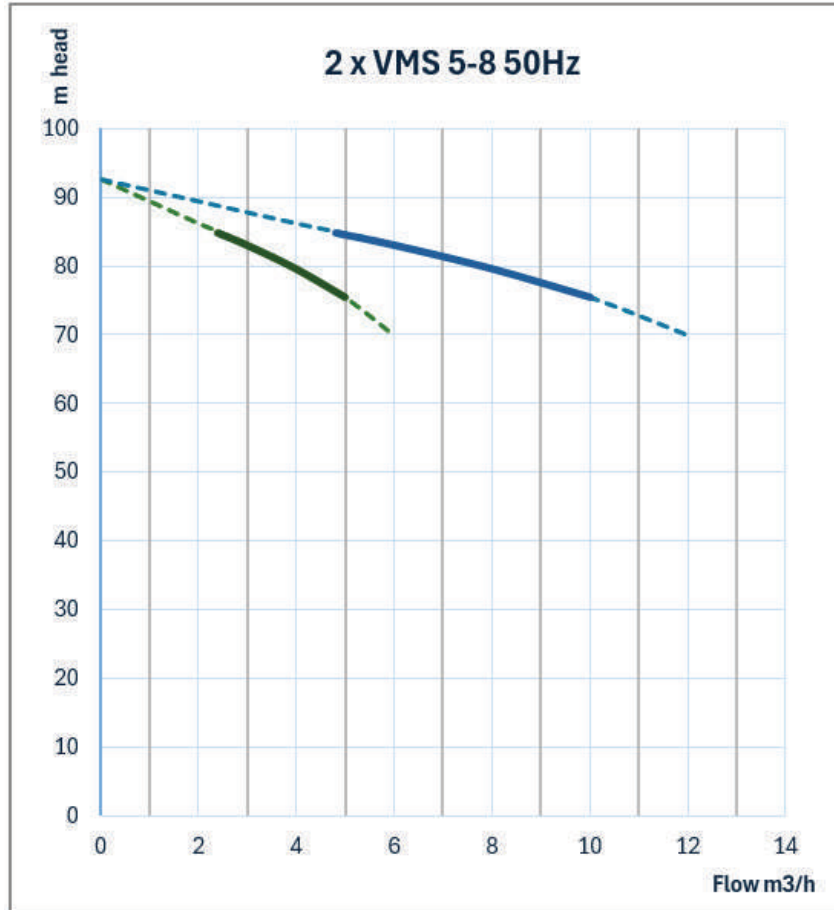

CUTAWAY AND MATERIALS

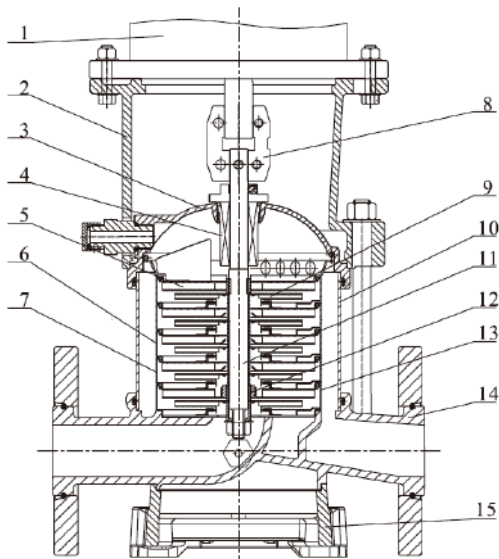

1	Motor	/
2	Bracket	Ductile Cast Iron
3	Seal Base	Stainless / Ductile Cast Iron
4	Mechanical Seal	AS-L-16
5	Top Diffuser	Stainless Steel
6	Diffuser	Stainless Steel
7	Support Diffuser	Stainless Steel
8	Coupling	Stainless Steel
9	Impeller	Stainless Steel
10	Cylinder	Stainless Steel
11	Shaft	Stainless Steel
12	Intermediate Bearing	SIC / WC
13	Inducer	Stainless Steel
14	Inlet/Outlet Chamber	Stainless Steel / Ductile Cast Iron
15	Base	Ductile Cast Iron

PRODUCT DATA SHEET

SUMMIT SERIES VERTICAL MULTISTAGE

DRIVE KIT

BIA-1VMS5/8T-DRIVE • 812402

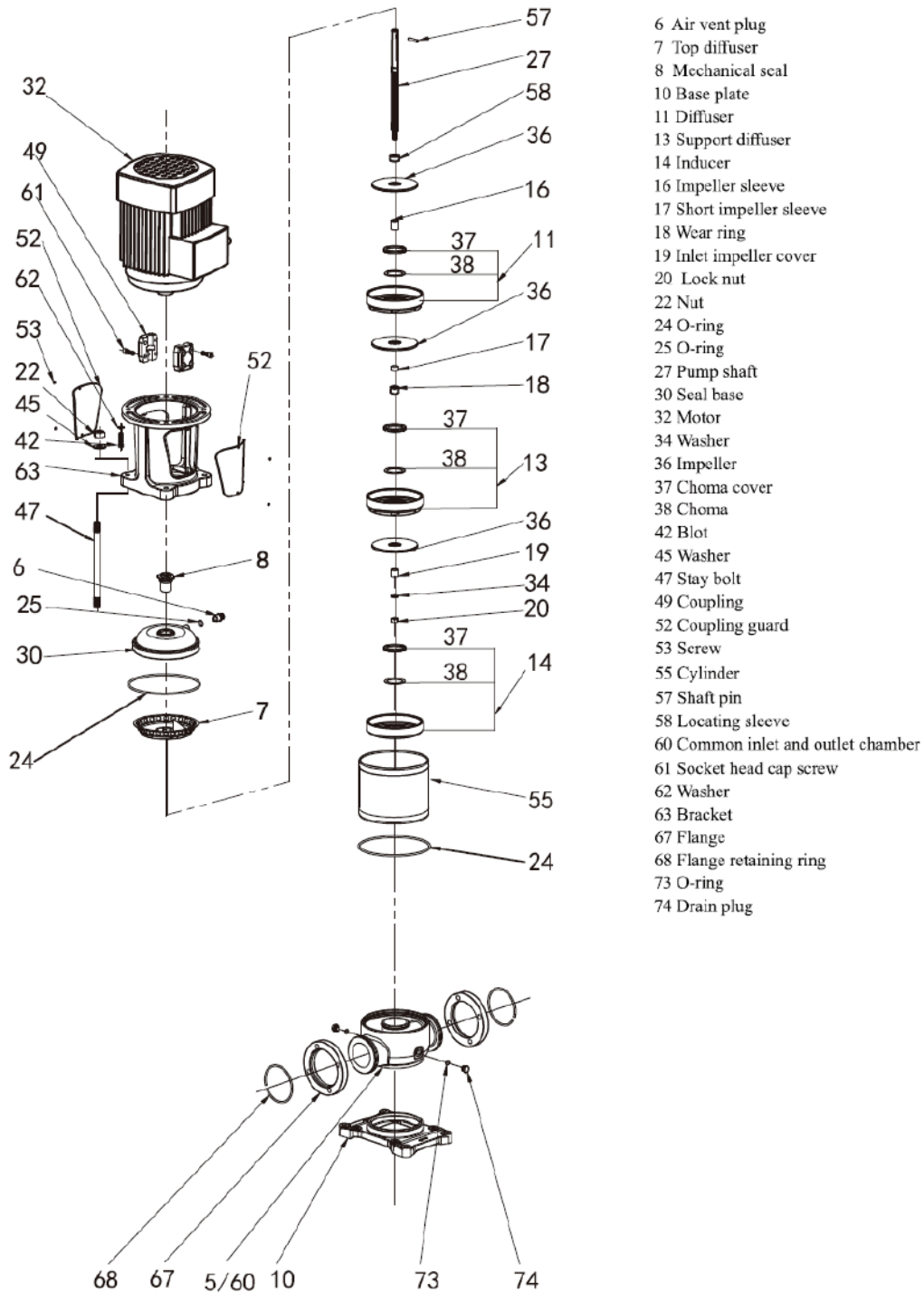

WARRANTY / CERTIFICATIONS

